



www.trukhino.com



PT HINO MOTORS SALES INDONESIA  
Wisma Indomobil II, Jl Letjen MT. Haryono Kav. 9, DKI Jakarta 13330

☎ 0 800 100 4466    @HinoID    Fanpage: Hino Indonesia    HinoID  
@ hino.hotline@hino.co.id    Hino Indonesia    www.hino.co.id



PT.HINO MOTORS SALES INDONESIA selalu mengadakan riset dan perkembangan teknologi, serta berhak melakukan perubahan spesifikasi untuk meningkatkan mutu dan melakukan penyesuaian tanpa pemberitahuan terlebih dahulu. Body dan warna karoseri dalam brosur ini merupakan opsional, bukan standar. Dapatkan performa kendaraan terbaik dengan menggunakan suku cadang asli-Hino Genuine Part (HGP) & HMSI Original Part (HOP). Informasi lebih lanjut, kunjungi dealer resmi Hino terdekat atau hubungi Hino Customer Care Center.

All Line Up  
**KATALOG**  
HINO300 | HINO500 | HINOBus



**TANGGUH DI JALAN**  
**UNTUNG DI TANGAN**

**Rochmat Nurhidayat**  
**0821 2520 5399**



PT. Hino Motors Sales Indonesia

# HINO300 Series

Hino Dutro merupakan produk unggulan di kelas *light duty truck* (LDT) baik itu 4 roda ataupun 6 roda. Hino Dutro memiliki beragam model untuk memenuhi kebutuhan bisnis Anda, seperti kargo, *dump* dan *mixer*. Hino Dutro solusi untuk mengangkut banyak barang untuk medan yang sempit karena truk ini mudah manuver di jalan sempit sekalipun.

## CARGO

**4 Roda :**  
115 SD | 115 SDR  
115 SDL

**6 Roda :**  
115 LD | 136 MD  
136 MDL | 136 HDL



## DUMP

**6 Roda :**  
115 HD | 136 HD  
136 HDX  
136 HDX LSD



# DUTRO



## 136 HDX MIXER

## Mesin Euro4 Hino Dutro



### N04C Common Rail | Euro4

Hino Dutro sudah dilengkapi dengan teknologi mesin Euro4. Sistem bahan bakar berkualitas, kendali emisi gas buang yang akurat dan sistem kendali terintegrasi dengan ECU generasi ke-4 inilah bukti kesiapan Hino membuat bisnis Anda lebih mudah.



EGR (Exhaust Gas Recirculation System) adalah sistem yang menurunkan kandungan senyawa negatif (NOx) dari emisi sisa gas buang.



DOC (Diesel Oxidation Catalyst) komponen logam yang mengandung katalis yang dapat mengubah dan mengurangi emisi gas buang berbahaya.

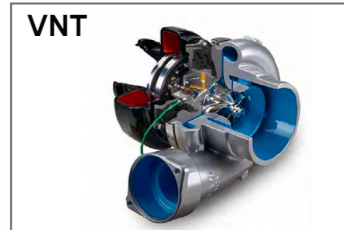

VNT (Variable Nozzle Turbo) adalah teknologi turbo modern yang beroperasi secara variabel dengan kontrol elektrikal membuat pembakaran optimal.

### Common Rail System



Common Rail dengan G4S series injector, memiliki sistem valve baru yang mampu menghilangkan *static/dynamic leak* sehingga konsumsi bahan bakar akan lebih baik dan daya tahan terhadap keausan lebih tinggi.



### Transmisi RE50

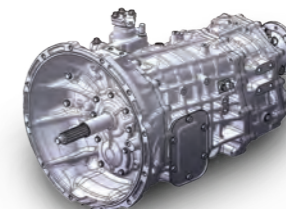

### Transmisi RE61 (New)



DUTRO SPESIFIKASI	CARGO - 4 RODA			CARGO - 6 RODA	
	115 SD STD	115 SDR STD	115 SDL STD	115 LD STD	136 MD STD
Model / Series	N04C-WV			N04C-WY	
Tipe / Type + Emisi / Emission	Mesin Diesel 4 Langkah Segaris; Variable Nozzle Turbocharger; Intercooler; Common Rail + Euro IV				
Sistem Kontrol Emisi / Emission Control System	EGR + DOC				
Tenaga Maks. / Max. Power (PS/rpm)	115 / 2.500			136 / 2.500	
Torsi Maks. / Max. Torque (Kgm/rpm)	36 / 1.200-2.200			40 / 1.400-2.500	
TRANSMISI / TRANSMISSION	RE50			RE50	
PERBANDINGAN GIGI AKHIR / FINAL GEAR RATIO	4,625			5,125	
DIMENSI / DIMENSION	Jarak Sumbu Roda / Wheelbase (mm)	2.530		3.380	
	Panjang Total / Overall Length (mm)	4.745	5.090	6.430	6.345
GVWR (kg)	5.400			7.000	8.250
UKURAN BAN / TIRE SIZE	7.50-15-14PR			7.00-16-14PR	7.50-16-14PR

CARGO - 6 RODA		DUMP - 6 RODA			MIXER - 6 RODA
136 MDL STD	136 HDL	115 HD STD	136 HD	136 HDX LSD	136 HDX Mixer*
N04C-WY		N04C-WV			N04C-WY
Mesin Diesel 4 Langkah Segaris; Variable Nozzle Turbocharger; Intercooler; Common Rail + Euro IV					
EGR + DOC		EGR + DOC			
136 / 2.500		115 / 2.500		136 / 2.500	
40 / 1.400-2.500		36 / 1.200-2.200		40 / 1.400-2.500	
RE50	RE61	RE50		RE61	
5.125	5.857/6.428	6.428	6.428/6.833	5.857/6.833	6.833
4.000		3.380			
7.184	7.185	6.025		6.026	
8.250	8.600	7.500		8.600	
7.50-16-14PR		7.50-16-14PR		7.50-16-14PR (LUG)	7.50-16-14PR

\*telah dilengkapi PTO.

# Mesin Euro4 Hino Ranger



Hino Ranger memang dirancang untuk operasional di lapangan secara maksimal selama 24 jam dan 7 hari bahkan dibawah kondisi yang paling ekstrem sekalipun. Dilengkapi dengan teknologi mesin Euro4 yang memiliki sistem bahan bakar berkualitas, kendali emisi gas buang yang akurat dan sistem kendali terintegrasi dengan ECU generasi ke-4. Inilah bukti kesiapan Hino di era Euro4 untuk membuat bisnis Anda lebih mudah.

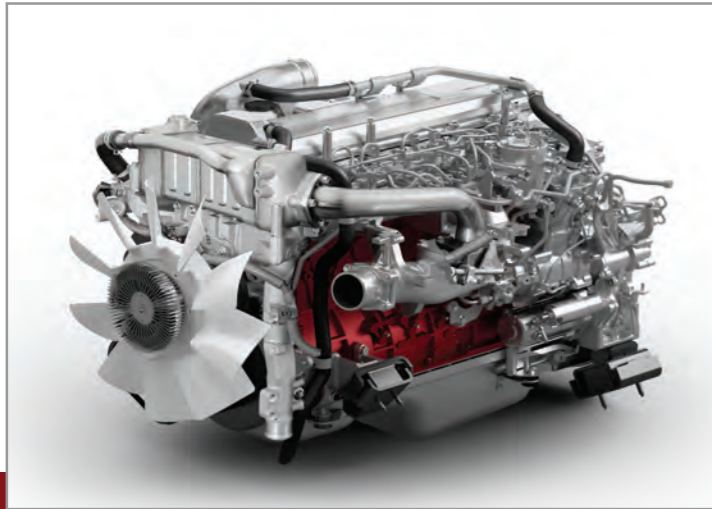

J08E Common Rail | Euro4



PI1C Common Rail | Euro4

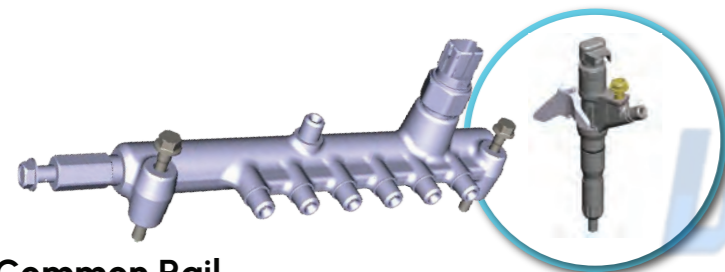

Injector DLC  
(Diamond Like Carbon)



EGR

## Common Rail

Common Rail dengan G4S series injector, memiliki sistem valve baru yang mampu menghilangkan static/dynamic leak sehingga konsumsi bahan bakar akan lebih baik dan daya tahan terhadap keausan lebih tinggi.

EGR (Exhaust Gas Recirculation System) Adalah sistem yang menurunkan senyawa negatif (NOx) dari emisi sisa gas buang.

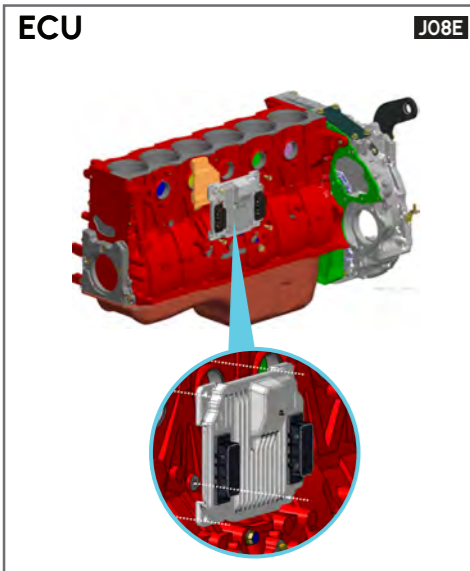

ECU (Engine Electronic Control Unit) berfungsi sebagai pengatur kinerja mesin agar performa kendaraan lebih maksimal.

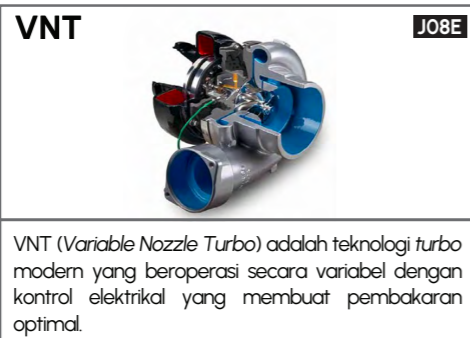

VNT (Variable Nozzle Turbo) adalah teknologi turbo modern yang beroperasi secara variabel dengan kontrol elektrik yang membuat pembakaran optimal.

Pada mesin terbaru HINO digunakan juga V-Belt Autotensioner, yang akan mengatur ketegangan fanbelt secara otomatis. Membuat perawatan lebih mudah.



DOC (Diesel Oxidation Catalyst) komponen logam dengan katalis yang dapat berubah dan mengurangi emisi gas buang berbahaya.

SCR (Selective Catalytic Reduction) teknologi pengendalian sisa pembakaran mampu mengurangi 80-95 % emisi NOx. Dengan cara mencampurkan urea cair/amonia (NH3) dan oksigen (O2) yang ada di katalis, dengan NOx untuk membentuk molekul nitrogen (N2) dan air (H2O), sehingga gas buang lebih bersih dan ramah lingkungan.

# HINO500 Series



Hino Ranger menguasai pasar dengan market share lebih dari 50%, selama lebih dari 22 Tahun hingga saat ini. Membuat Hino Ranger terus sebagai market leader di Indonesia. Truk ini sudah terbukti kualitas dan kekuatannya di medan ekstrem sekalipun, membuat Hino Ranger selalu menjadi pilihan utama para pengusaha.



## TRACTOR HEAD

Truk 4 x 2 :  
FG 260 TH | SG 280 TH

Truk 6 x 4 :  
FM 280 TH | FM 340 TH

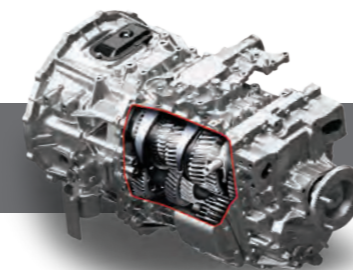

Transmisi MX06



Transmisi MX07 (New)

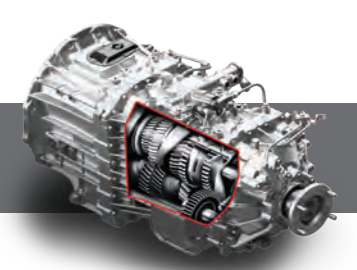

Transmisi M0090D | M009DD



# MIXER

Truk 6x4 :  
FM 280 JM | FM 280 JL



# DUMP

Truk 4x2 :  
FG 260 JJ

Truk 6x4 :  
FM 260 JD | FM 280 JD  
FM 280 JD (Mining Spec)  
FM 340 PL | FM 340 PD



# CARGO

Truk 4x2 :  
FG 240 JP | FG 260 JP  
FG 260 JK | FG 260 JL  
FG 260 JM | FG 260 JS

Truk 6x2 :  
FL 260 JN | FL 260 JW  
FL 280 JT | FL 280 JW

Truk 6x4 :  
FM 280 JW

## RANGER SPESIFIKASI

	CARGO 4x2					CARGO 6x2				CARGO 6x4		
	FG 240 JP	FG 260 JP	FG 260 JK*	FG 260 JL	FG 260 JM	FG 260 JS	FL 260 JN*	FL 260 JW*	FL 280 JT	FL 280 JW	FM 280 JW	
Model / Series	JO8E-WF		JO8E-WE						JO8E-WD			
Tipe / Type + Emisi / Emission	Mesin Diesel 4 Langkah Segaris; Variable Nozzle Turbocharger; Intercooler Common Rail + Euro IV											
Sistem Kontrol Emisi / Emission Control System	EGR + DOC											
MESIN / ENGINE	Tenaga Maks. / Max. Power	(PS/rpm) 245/2.500				265/2.500				285/2.500		
	Torsi Maks. / Max. Torque	JIS-Gross (Kgml/rpm) 74/1.500				82/1.500				85/1.500		
	Tenaga Maks. / Max. Power	ISO-NET (PS/rpm) 240/2.500				260/2.500				280/2.500		
	Torsi Maks. / Max. Torque	(Kgml/rpm) 73/1.500				81/1.500				84/1.500		
TRANSMISI / TRANSMISSION	MX06		MX07						M009DD			
PERBANDINGAN GIGI AKHIR / FINAL GEAR RATIO	6,428					5,857				6,428		
DIMENSI / DIMENSION	Jarak Sumbu Roda / Wheelbase (mm)	5.530	4.630	4.780	5.080	6.130	4.030+1.350	6.130+1.350	4.930+1.350	6.130+1.350	6.130+1.350	
	Panjang Total / Overall Length (mm)	9.700		8.150	8.650	8.850	10.600	8.950	11.950	9.950	11.950	
GVWR / GCWR (kg)	14.200		16.000						26.000			
UKURAN BAN / TIRE SIZE	9.00-20-14PR		10.00-20-16PR						11.00-20-16PR			

\*Hadir dengan tipe ABS dan tanpa ABS

DUMP 4x2	DUMP 6x4					MIXER 6x4		TRACTOR HEAD 4x2		TRACTOR HEAD 6x4		
FG 260 JJ**	FM 260 JD**	FM 280 JD**	FM 280 JD** (Mining Spec)	FM 340 PL**	FM 340 PD**	FM 280 JM**	FM 280 JL**	FG 260 TH	SG 280 TH*	FM 280 TH*	FM 340 TH*	
JO8E-WE		JO8E-WD			PIIC-WN		JO8E-WD		JO8E-WE		JO8E-WD	
Mesin Diesel 4 Langkah Segaris; Variable Nozzle Turbocharger; Intercooler; Common Rail + Euro IV			Mesin Diesel 4 Langkah Segaris; Intercooler; Common Rail + Euro IV		Mesin Diesel 4 Langkah Segaris; Intercooler; Common Rail + Euro IV		Mesin Diesel 4 Langkah Segaris; Variable Nozzle Turbocharger; Intercooler; Common Rail + Euro IV					Mesin Diesel 4 Langkah Segaris; Intercooler; Common Rail + Euro IV
EGR + DOC			SCR		EGR + DOC		EGR + DOC		EGR + DOC		SCR	
265/2.500		285/2.500			350/2.500		285/2.500		265/2.500		285/2.500	
82/1.500		85/1.500			134/1.500		85/1.500		82/1.500		85/1.500	
260/2.500		280/2.500			340/2.100		280/2.500		260/2.500		280/2.500	
81/1.500		84/1.500			130/1.500		84/1.500		81/1.500		130/1.500	
MX07		M009DD			M009OD		M009DD		MX07		M009DD	
6,428		6,428			5,857		6,428		6,833		5,428	
4.330		4.030+1.350			3.480+1.350		3.930+1.350		3.280+1.350		3.580+1.350	
7.600		8.600			7.600		8.700		7.420		7.735	
16.000		26.000			26.000		26.000		34.000		37.000	
10.00-20-16PR		11.00-20-16PR			11.00-R20-18PR		11.00-20-16PR		10.00-R20-16PR		11.00-R22.5-148/145	
											295/80R22.5*	

\*\*telah dilengkapi PTO. \*Hadir dengan tipe ABS dan tanpa ABS

# Mesin Euro4 Hino BUS



Sistem bahan bakar berkualitas, kendali emisi gas buang yang akurat dan sistem kendali terintegrasi dengan ECU generasi ke-4, adalah wujud kesiapan mesin Hino Euro4.



N04C Common Rail | Euro4

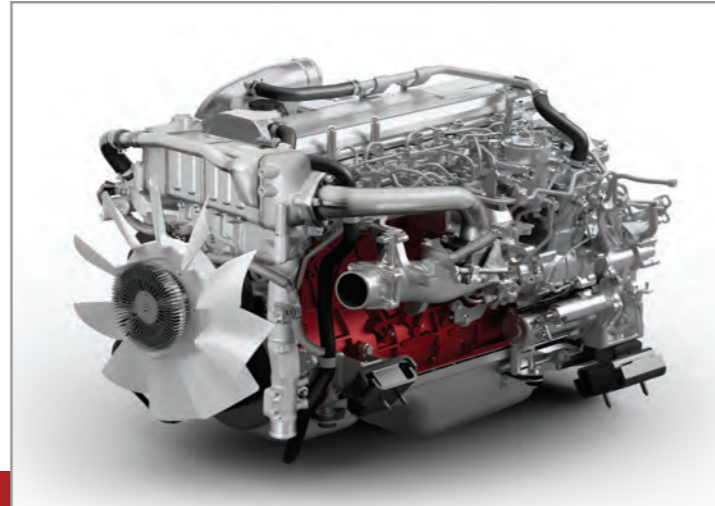

J08E Common Rail | Euro4

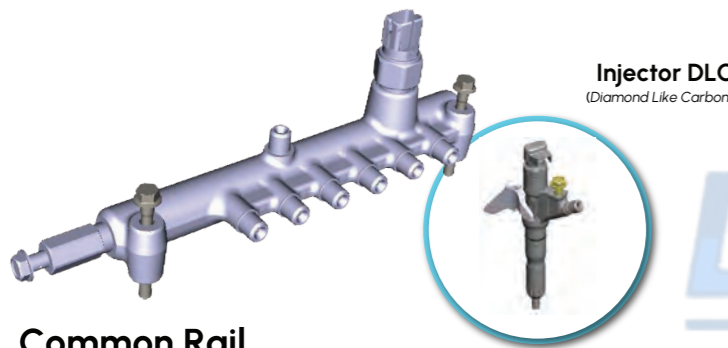

Injector DLC  
(Diamond Like Carbon)

## Common Rail

Common Rail dengan G4S series injector, memiliki sistem valve baru yang mampu menghilangkan static/dynamic leak sehingga konsumsi bahan bakar akan lebih baik dan daya tahan terhadap keausan lebih tinggi.



## EGR

EGR (Exhaust Gas Recirculation System) Adalah sistem yang menurunkan senyawa negatif (NOx) dari emisi sisa gas buang.

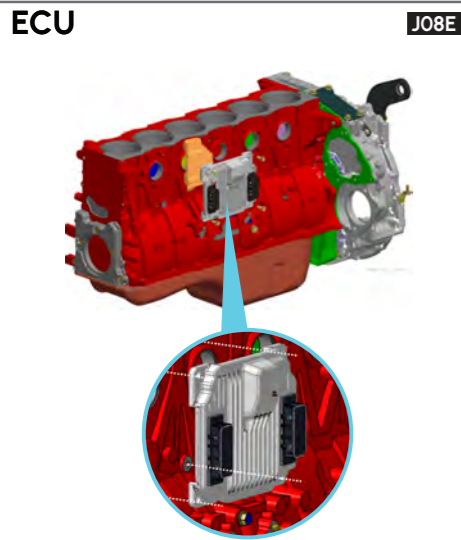

ECU

J08E

ECU (Engine Electronic Control Unit) berfungsi sebagai pengatur kinerja mesin agar performa kendaraan lebih maksimal.



VNT

J08E  
N04C

VNT (Variable Nozzle Turbo) adalah teknologi turbo modern yang beroperasi secara variabel dengan kontrol elektrikal yang membuat pembakaran optimal.

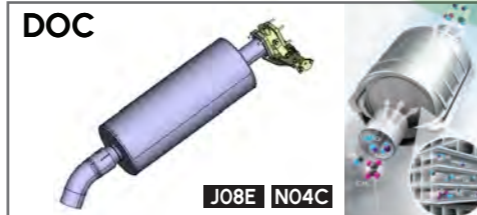

DOC

J08E N04C

DOC (Diesel Oxidation Catalyst) komponen logam yang mengandung katalis dapat mengubah dan mengurangi emisi gas buang berbahaya.

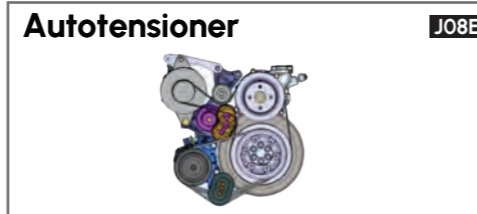

Autotensioner

J08E

Pada mesin terbaru HINO digunakan juga V-Belt Autotensioner, yang akan mengatur ketegangan fanbelt secara otomatis. Membuat perawatan lebih mudah.

# HINO Bus Series



Hino Bus jaminan kenyamanan berkualitas tinggi. Hadir untuk memberikan layanan mobilitas yang tinggi, aman, dan hemat biaya. Hino Bus dapat digunakan untuk berbagai kebutuhan transportasi seperti antar kota antar provinsi, dalam kota, pariwisata, dan bisnis lainnya.



## BIG BUS

Mesin Belakang:  
RK280 | RK280 ABS  
RM280 | RM280 ABS

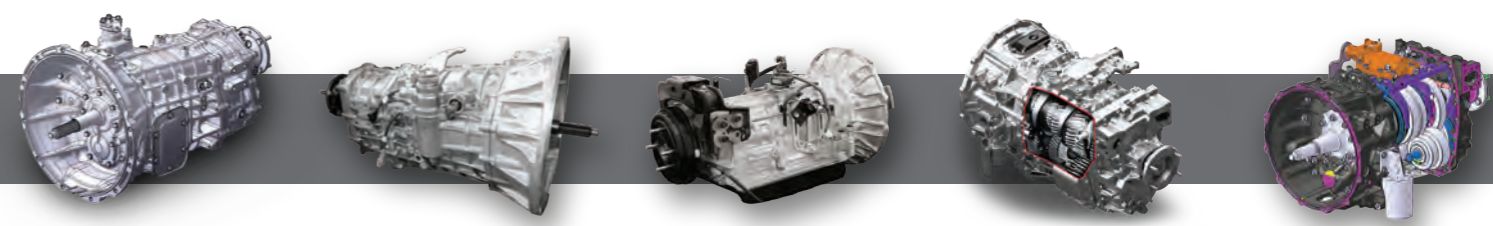

Transmisi RE50    Transmisi RE61 (New)    Transmisi AB60E (New)    Transmisi MX06    Transmisi MX07 (New)



## MEDIUM BUS

6 Roda :  
136 MDBL  
GB 150 | GB 150 L  
GB 150 AT | GB 150L AT



## BIG BUS

Mesin Depan:  
AK 240



## MICRO BUS

4 Roda :  
115 SDB | 115 SDBL

BUS SPESIFIKASI		MICRO BUS		MEDIUM BUS	
		115 SDB	115 SDBL	136 MDBL	GB 150
Model / Series		N04C-WV		N04C-WY	N04C-WK
Tipe / Type + Emisi / Emission		Mesin Diesel 4 Langkah Segaris; Variable Nozzle Turbocharger; Intercooler; Common Rail + Euro IV			
Sistem Kontrol Emisi / Emission Control System		EGR + DOC			
MESIN / ENGINE	Tenaga Maks. / Max. Power (PS/rpm)	-			
	Torsi Maks. / Max. Torque (Kgm/rpm)	-			
	Tenaga Maks. / Max. Power (ISO-NET) (PS/rpm)	115 / 2.500		136 / 2.500	150 / 2.500
	Torsi Maks. / Max. Torque (ISO-NET) (Kgm/rpm)	36 / 1.200-2.200		40 / 1.400-2.500	42.8 / 1.400
TRANSMISI / TRANSMISSION		RE50		RE61	
PERBANDINGAN GIGI AKHIR / FINAL GEAR RATIO		4.625		5.125	5.571/5.142
DIMENSI / DIMENSION	Jarak Sumbu Roda / Wheelbase (mm)	2.530	3.405	4.000	3.870
	Panjang Total / Overall Length (mm)	5.075	6.430	7.185	7.790
GVWR (kg)		5.400		7.500	8.000
UKURAN BAN / TIRE SIZE		235/65R16C (Radial Tubeless)		7.50-16-14PR	215/75R17.5 (Radial Tubeless)

MEDIUM BUS			BIG BUS		
GB 150 L	GB 150 AT	GB 150 L AT	AK 240	RK 280*	RM 280*
N04C-WK			J08E-WF	J08E-WD	
Mesin Diesel 4 Langkah Segaris; Variable Nozzle Turbocharger; Intercooler; Common Rail + Euro IV					
EGR + DOC					
-			245/2.500	285/2.500	
-			74/1.500	85/1.500	
150 / 2.500			240/2.50	280/2.500	
42.8 / 1.400			73/1.500	84/1.500	
RE61	A860E (AT)		MX06		MX07
5.571/5.142	5.857/5.142		5.428	4.875	5.857
4.200	3.870	4.200	5.800	6.000	
8.280	7.780	8.280	11.110	11.700	
8.000			15.000	15.500	16.000
215/75R17.5 (Radial Tubeless)			11R22.5 148/145 (Radial Tubeless)		

\*Hadir dengan tipe ABS dan tanpa ABS